

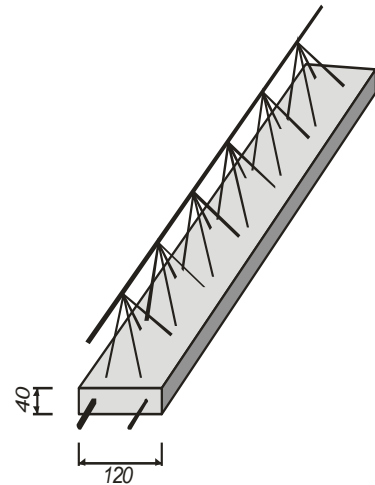

## Perdangos TERIVA elementų kainos

Perdangos TERIVA sijų kainos			
Sijos ilgis, m	Sijos kaina, EUR be PVM*	Sijos kaina, EUR su PVM*	
1,8	8,33	10,08	
2,0	9,25	11,19	
2,2	10,18	12,32	
2,4	11,10	13,43	
2,6	12,02	14,54	
2,8	12,96	15,68	
3	14,50	17,55	
3,2	15,47	18,72	
3,4	16,43	19,88	
3,6	18,13	21,94	
3,8	19,14	23,16	
4	20,14	24,37	
4,2	22,87	27,67	
4,4	23,97	29,00	
4,6	25,05	30,31	
4,8	27,13	32,83	
5	28,27	34,21	
5,2	30,45	36,84	
5,4	34,95	42,29	
5,6	36,25	43,86	
5,8	38,72	46,85	
6	42,52	51,45	
6,2	43,93	53,16	
6,4	45,35	54,87	
6,6	46,77	56,59	
6,8	48,19	58,31	
7	55,34	66,96	
7,2	56,93	68,89	
7,4	58,50	70,79	
7,6	60,09	72,71	
7,8	61,67	74,62	
8,0	59,97	72,56	
8,2	61,47	74,38	
8,4	62,96	76,18	
8,6	64,46	78,00	

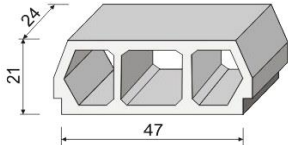
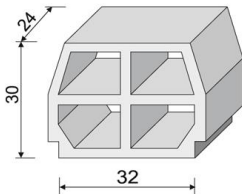
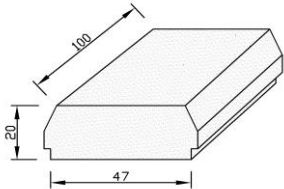
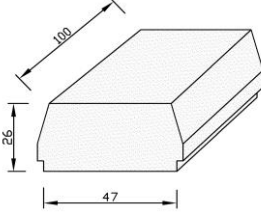
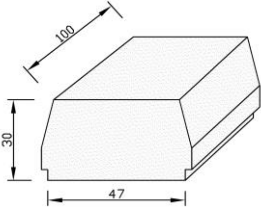
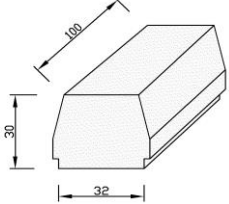

\* PVM 21 %

Perdangos TERIVA blokelių kainos			
Blokelio tipas	Vnt. Kaina, EUR be PVM*	Vnt. Kaina, EUR su PVM*	
<b>T - 600 B</b> (betoninis)	1,29	<b>1,56</b>	
<b>T - 450 K</b> (keramzitbetonio)	2,48	<b>3,00</b>	
<b>T - 600 L/01 (EPS)</b>	7,82	<b>9,46</b>	
<b>T - 600 L /02</b> (EPS)	8,98	<b>10,87</b>	
<b>T - 600 L /03</b> (EPS)	10,43	<b>12,62</b>	
<b>T-450 L</b> (EPS)	8,40	<b>10,16</b>	

\* PVM 21 %

### Uždaroji akcinė bendrovė "PREFABETA"

Panerių g. 51-311, Vilnius, tel. +370 52339662, +370 61005515, [info@teriva.lt](mailto:info@teriva.lt), [www.teriva.lt](http://www.teriva.lt)  
 Įm. k. 125976935, PVM kodas LT259769314, A/s LT 567044060000435881 AB "SEB bankas"